

MSS.01.068.100



HONDA Transalp 650 Motorschutz Montagehinweise

Alle vom Motorrad gelösten Schrauben sind gemäß Herstellerangaben wieder zu montieren, oder mit von SW-MOTECH gelieferten Schrauben zu ersetzen. Falls nicht anderweitig definiert, diese Schrauben nach Tabelle anziehen.

M6	9,6 Nm
M8	23 Nm
M10	46 Nm

Gegebenenfalls Schrauben mit flüssiger Schraubensicherung einkleben.

Prüfen Sie nach 50 km alle Verbindungen auf festen Sitz.

SW-MOTECH GmbH & Co. KG
Ernteweg 8/10
35282 Rauschenberg
-Germany-

Tel.: ++ 49 (0) 6425 816 800
Fax: ++ 49 (0) 6425 816 810

www.sw-motech.com

Skid Plate Mounting Instructions

SW-MOTECH products should be installed by a qualified, experienced motorcycle technician. If you are unsure of your ability to properly install a product, please have the product installed by your local motorcycle dealer. SW-MOTECH takes no responsibility for damages caused by improper installation.

All screws, bolts and nuts, including all replacement hardware provided by SW-MOTECH, should be tightened to the torque specified in the OEM maintenance manual for your motorcycle. If no torque specifications are provided in the OEM maintenance manual, the following torques may be used:

M6	9,6 Nm
M8	23 Nm
M10	46 Nm







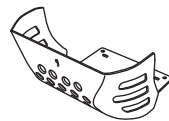

All screws, bolts and nuts should be checked after driving the first 50 km to ensure that all are tightened to the proper torque.

Medium strength liquid thread-locker (i.e., "Locktite") should be used to secure all screws, bolts and nuts.

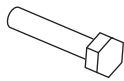
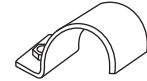
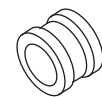
WARNING / ATTENTION

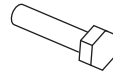
Achtung: Die Boden- und Schräglagenfreiheit kann bei Nutzung dieses Anbauteils eingeschränkt sein.

Attention: Cornering and ground clearance can be reduced by using this accessory.

<p>1 Motorschutz Skid Plate</p>  <p>MSS.01.068.900</p> <p>Anzahl/ Pcs. 1</p>	<p>5 Distanzbuchse Spacer</p>  <p>Da:8 Di:6,2 h:7</p> <p>Anzahl/ Pcs. 1</p>	<p>9 Sechskantschraube Hexagon Screw</p>  <p>M6 x 25 DIN 933</p> <p>Anzahl/ Pcs. 2</p>
<p>2 Klemmschelle Clamp</p>  <p>MSS.01.016.004</p> <p>Anzahl/ Pcs. 2</p>	<p>6 Gummitülle Rubberelement</p>  <p>GT.00.12H3472</p> <p>Anzahl/ Pcs. 1</p>	<p>10 Distanzbuchse Spacer</p>  <p>Da:20 Di:6,2 h:3</p> <p>Anzahl/ Pcs. 2</p>
<p>3 Sechskantschraube Hexagon Screw</p>  <p>M6 x 20 DIN 933</p> <p>Anzahl/ Pcs. 3</p>	<p>7 Gummidämpfer Rubber Bumper</p>  <p>MSS.00.03.016</p> <p>Anzahl/ Pcs. 2</p>	
<p>4 Unterlegscheibe Washer</p>  <p>A 6,4 DIN 9021</p> <p>Anzahl/ Pcs. 5</p>	<p>8 Gummischeibe Rubber Washer</p>  <p>6 x 20 x 3</p> <p>Anzahl/ Pcs. 2</p>	

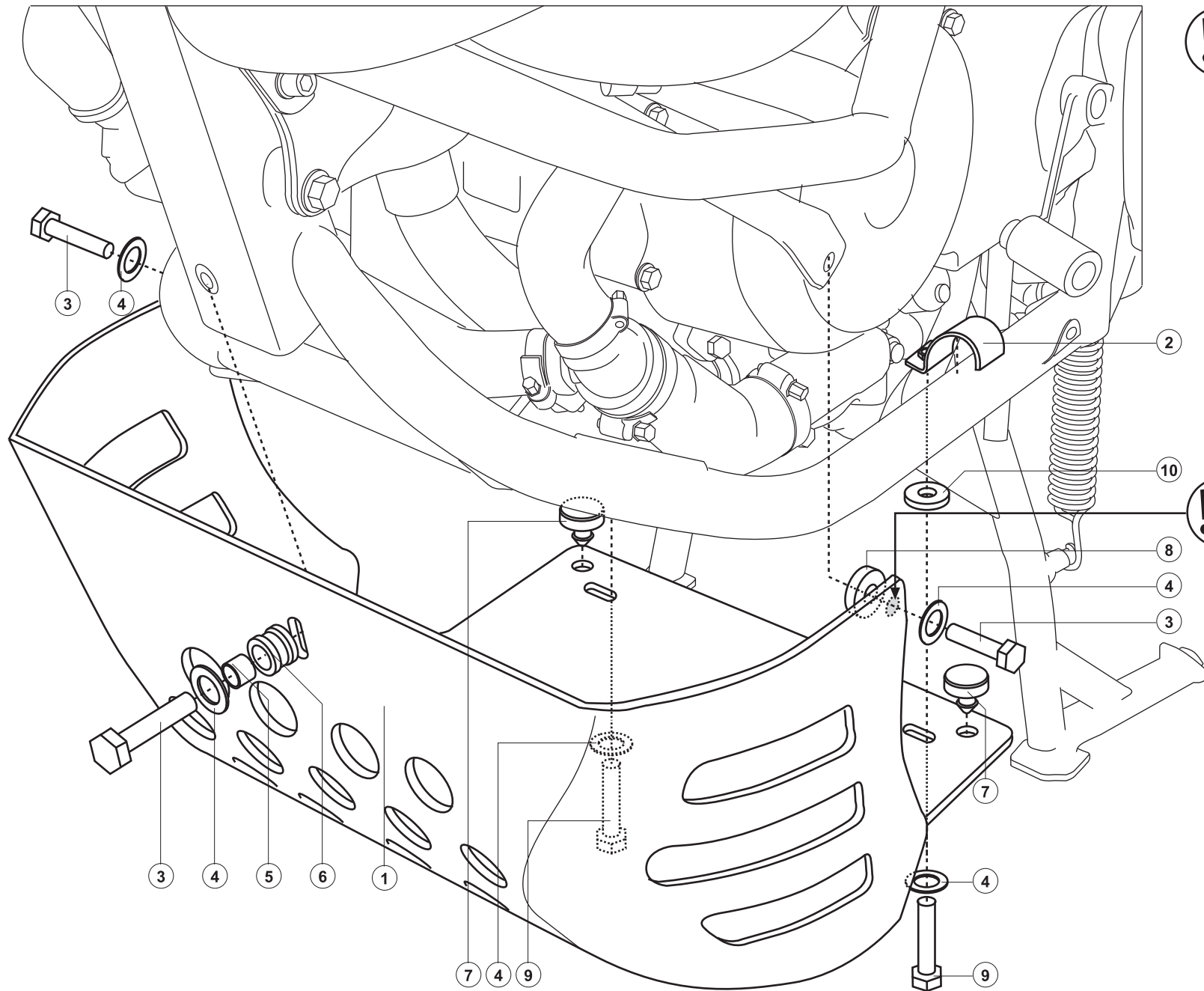

! Motorschutz an den unteren Anbaupunkten sowie dem vordern Anbaupunkt verschrauben. Anschließend die Position für Seitenbohrung ermitteln (mit Bohrsymbol markiert) und eine 7mm-Bohrung vornehmen. Montage anschließend gemäß Anbauanleitung.

Fix the engine guard to the points. Determine the position for the side drilling (marked with drill symbol) and a make a hole with a 7mm-driller. Assembly afterwards in accordance with installation instructions.

! Bohrung hier vornehmen!
Drilling make here!

