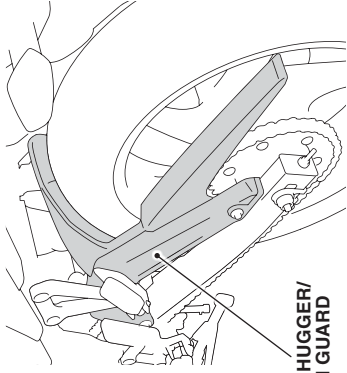
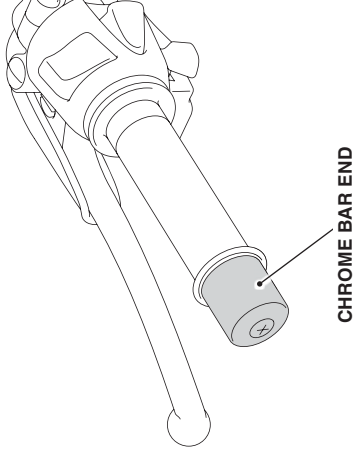

**REAR HUGGER/CHAIN GUARD**

- Check the accessory mounts frequently and retighten if necessary.
- Clean this accessory with a soft cloth soaked with a solution of mild detergent and water. Then wipe with a clean cloth soaked with water to clean dirt and detergent. Finally wipe dry with a soft, clean cloth.

**REAR HUGGER/  
CHAIN GUARD****CHROME BAR ENDS**

- Check the accessory mounts frequently and retighten if necessary.
- Clean this accessory with a soft cloth soaked with a solution of mild detergent and water. Then wipe with a clean cloth soaked with water to clean dirt and detergent. Finally wipe dry with a soft, clean cloth.

**CHROME BAR END****UNDER COWL**

- Check the accessory mounts frequently and retighten if necessary.
- Clean this accessory with a soft cloth soaked with a solution of mild detergent and water. Then wipe with a clean cloth soaked with water to clean dirt and detergent. Finally wipe dry with a soft, clean cloth.

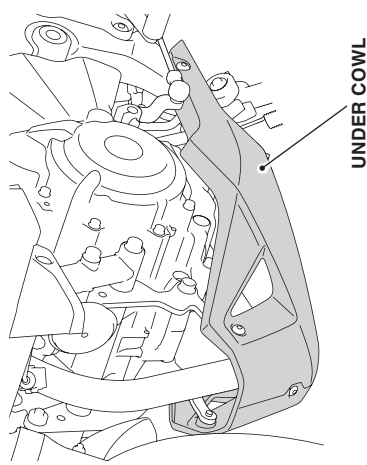
**UNDER COWL****HEADLIGHT LOWER COVER**

- Check the accessory mounts frequently and retighten if necessary.
- Clean this accessory with a soft cloth soaked with a solution of mild detergent and water. Then wipe with a clean cloth soaked with water to clean dirt and detergent. Finally wipe dry with a soft, clean cloth.

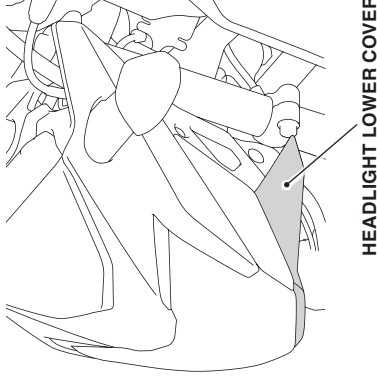
**HEADLIGHT LOWER COVER****PASSENGER SEAT COWL**

- Do not let anyone ride on the rear cowl and do not place luggage on it.
- Check the accessory mounts frequently.
- Clean this accessory with a soft cloth soaked with a solution of mild detergent and water. Then wipe with a clean cloth soaked with water to clean dirt and detergent. Finally wipe dry with a soft, clean cloth.
- Never use petroleum solvents such as gasoline, thinner or benzine to clean this accessory. Also do not use acid or alkaline cleaners.

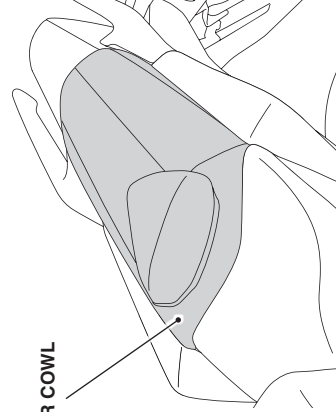
**REAR COWL**

# CB300F Genuine Accessory User's Guide

## TAIL BAG

TAIL BAG

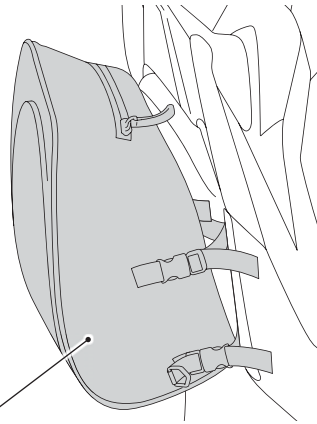

### CAUTION

To prevent burns, allow the engine, exhaust system, radiator, etc., to cool before installing the accessory.

- The weight of the cargo must not exceed the following maximum loading capacity:

11.0 lb (5.0 kg)

- Do not let anyone ride on the tail bag and do not place luggage on it.
- Remove the rear seat bag from the motorcycle when not in use.
- Check the accessory mounts frequently.
- Clean this accessory with a soft cloth soaked with a solution of mild detergent and water or a cleaner.
- If this accessory becomes completely wet (water has soaked through the material), remove this accessory and allow it to air dried at room temperature. Never dry this accessory in a dryer, in front of a heater, or near a fireplace.

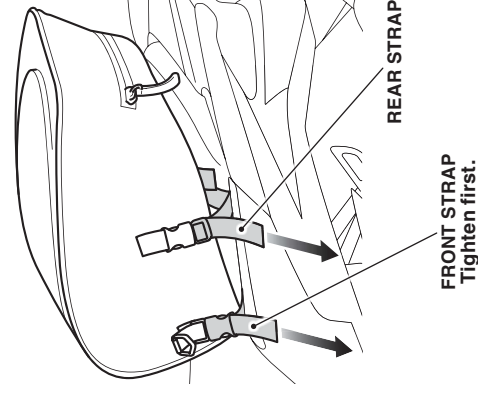

- Secure the right and left buckles as shown and tighten the straps while adjusting the balance between the right and left sides of the tail bag.
  - Tighten the front strap first and then the rear strap.
  - Secure well by pulling the straps tight.

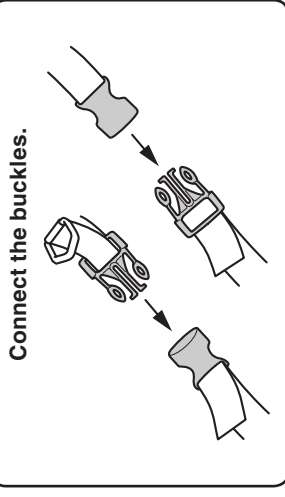

- Unlock the rear seat and insert the straps under the rear seat as shown.

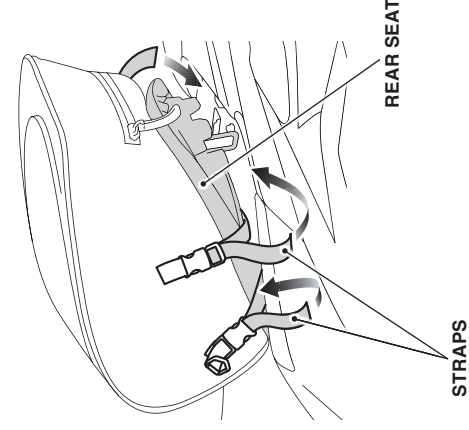

- Lock the rear seat.
  - Make sure that the rear seat is locked securely.

### REMOVAL

- Remove the rear seat bag in the reverse order of installation.

### HOW TO INSTALL THE REAR SEAT BAG

- Remove the rear seat.
- Secure the rear strap to the rear seat as shown.
  - Secure well by pulling the straps tight.

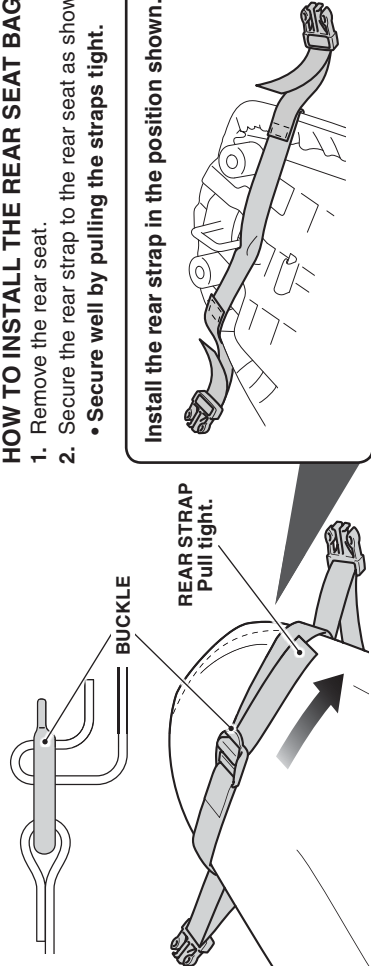

## SHOULDER STRAP

### HOW TO USE THE SHOULDER STRAP

- Hook the shoulder strap as shown.
  - Always store the shoulder strap when not in use.
  - Use the shoulder strap when carrying the tail bag.

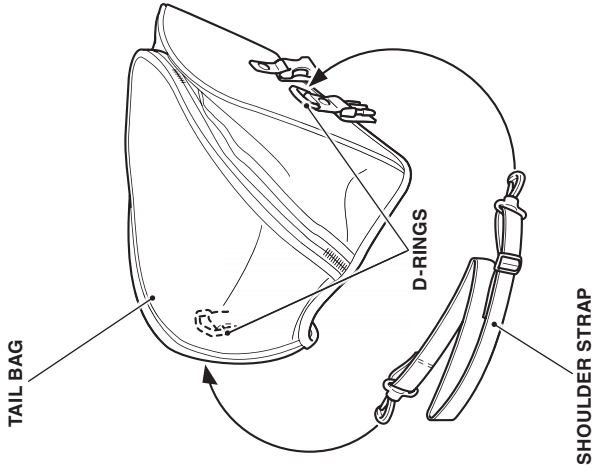

- Put the rain cover on the tail bag as shown.

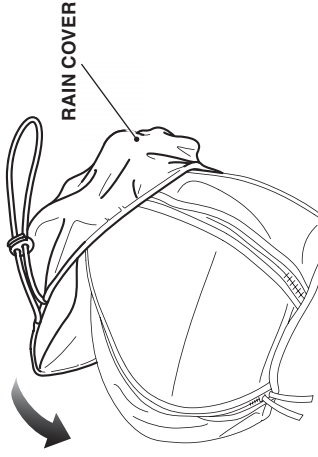

- Fasten the hook of the rain cover as shown.

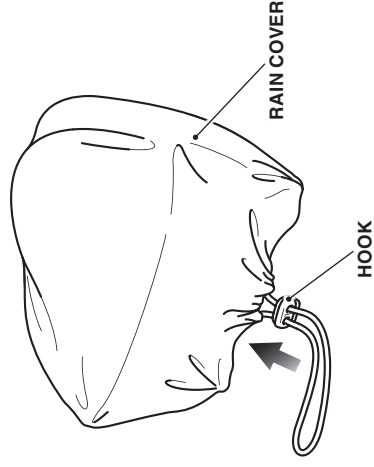

## RAIN COVER

### HOW TO USE THE RAIN COVER

- Open the zipper and pull out the rain cover as shown.

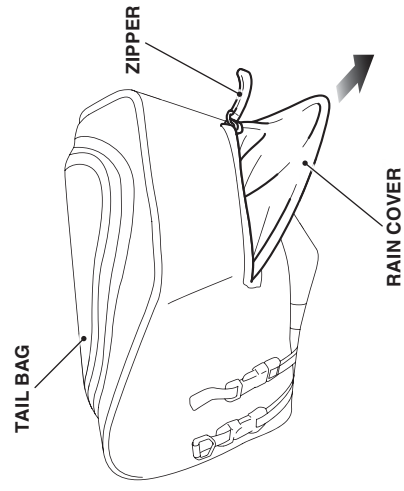

- Put the string in the space between the rear seat bag and rain cover as shown.

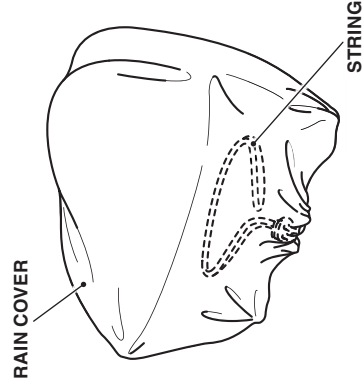

## FRONT FENDER

### TAIL BAG WHEN NOT IN USE

1. Remove the rear strap.
2. Put the front straps under the rear seat as shown and install the rear seat.
  - **Make sure that the front straps are under the rear seat.**

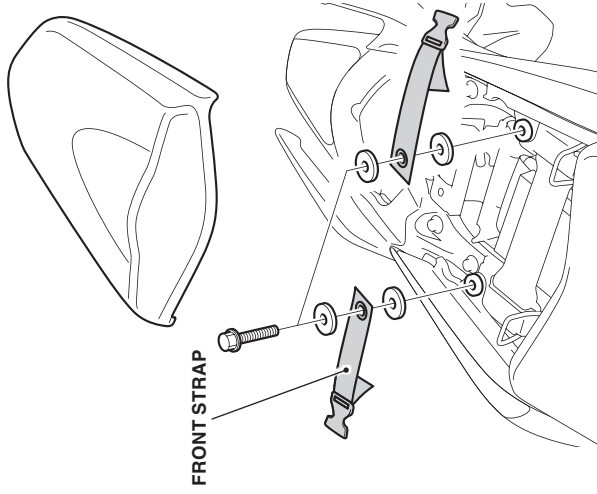

- Check the accessory mounts frequently and retighten if necessary.
- Clean this accessory with a soft cloth soaked with a solution of mild detergent and water. Then wipe with a clean cloth soaked with water to clean dirt and detergent. Finally wipe dry with a soft, clean cloth.

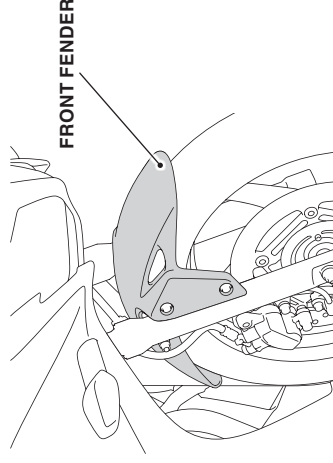

## TANK SHROUD

- Check the accessory mounts frequently and retighten if necessary.
- Clean this accessory with a soft cloth soaked with a solution of mild detergent and water. Then wipe with a clean cloth soaked with water to clean dirt and detergent. Finally wipe dry with a soft, clean cloth.

