



EVOTECH®
P E R F O R M A N C E

Honda CBR1000RR

Tail Tidy

Installation Instructions



Product No: PRN013719

Kit Contents

- A** 1 x Main Tail Tidy Bracket
- B** 1 x Indicator Bracket
- C** 1 x Light Bracket
- D** 1 x Retro Light
- E** 1 x Wire Connector
- F** 2 x Rubber Cap
- G** 6 x M4 x 8mm Button Head Bolt

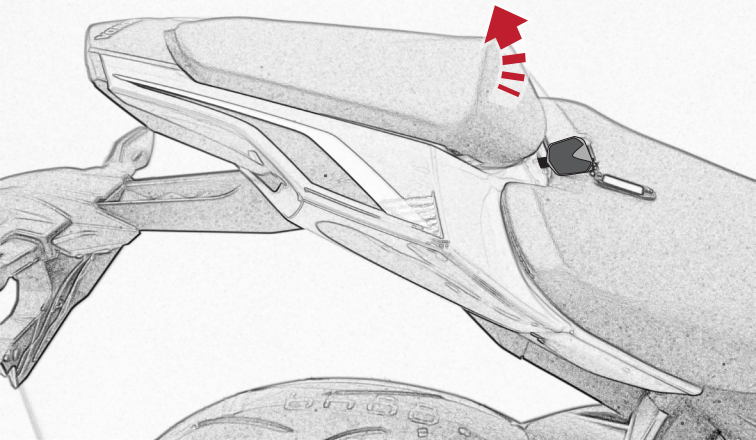



Repeat
Both Sides

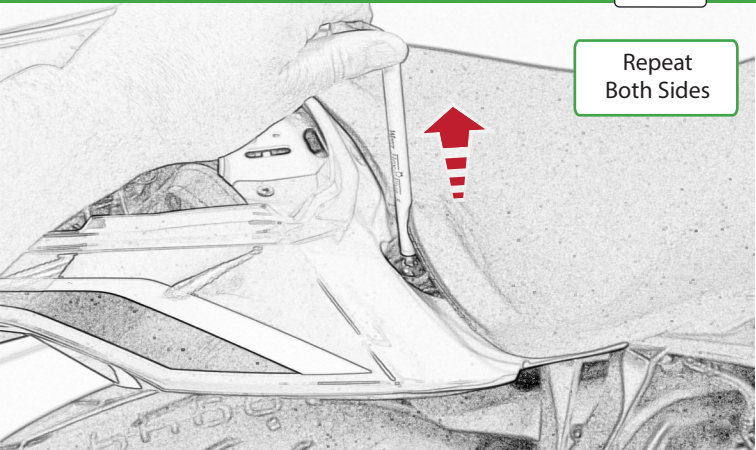

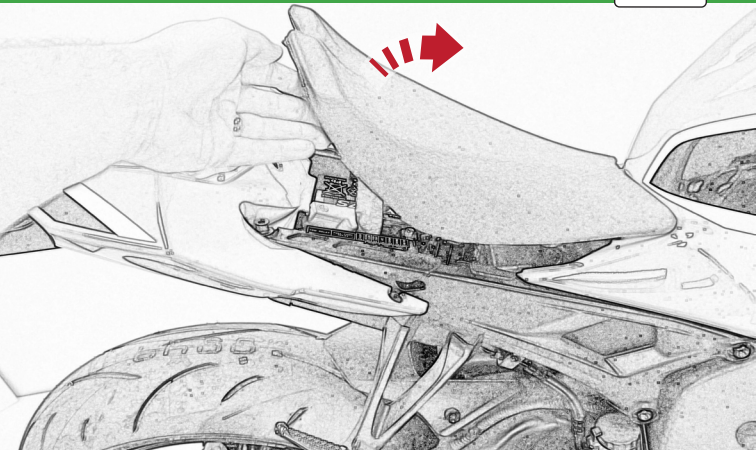

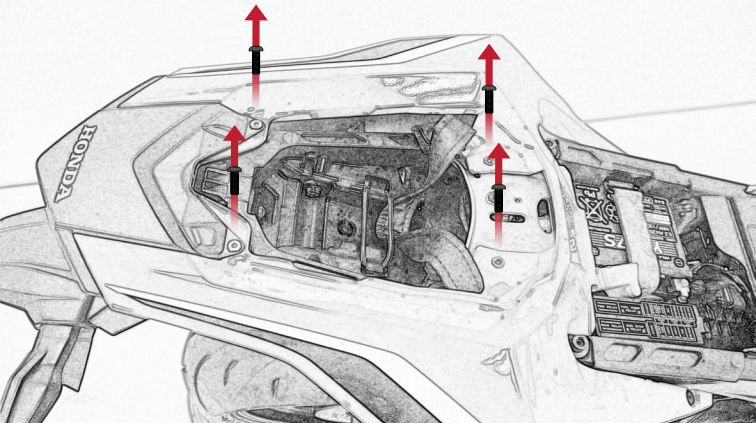

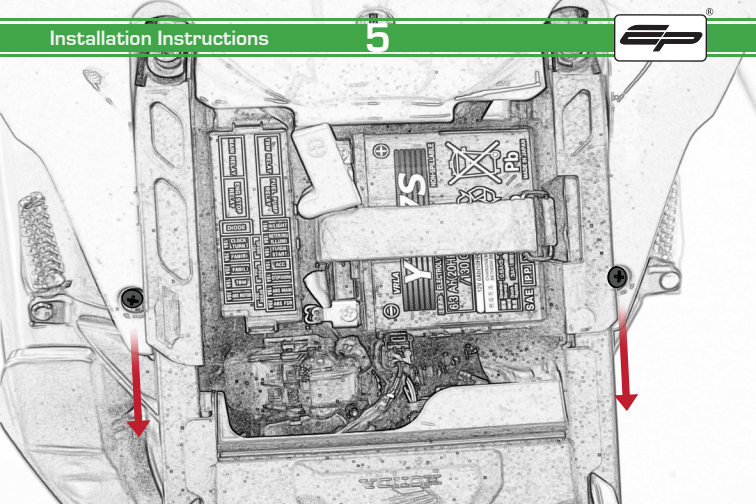

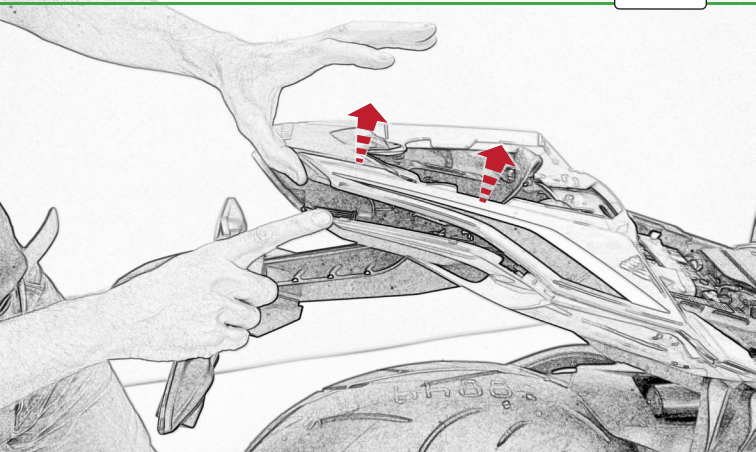

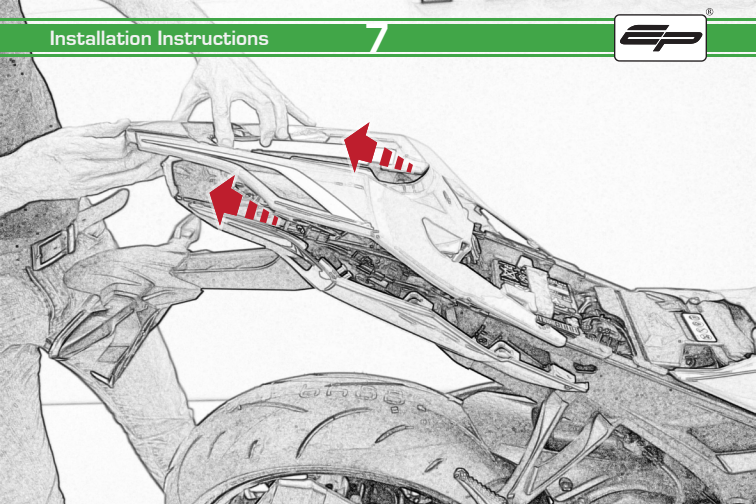

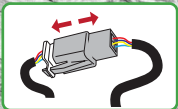
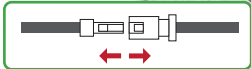
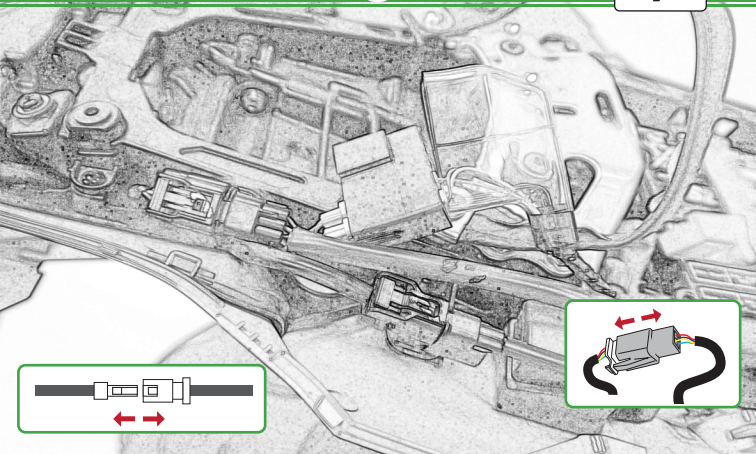

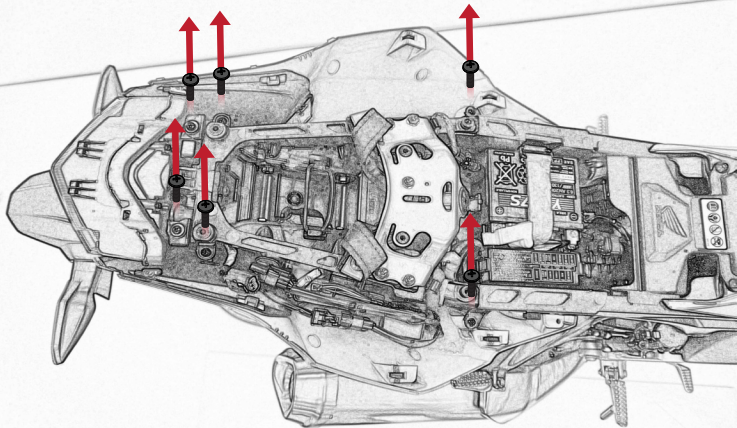

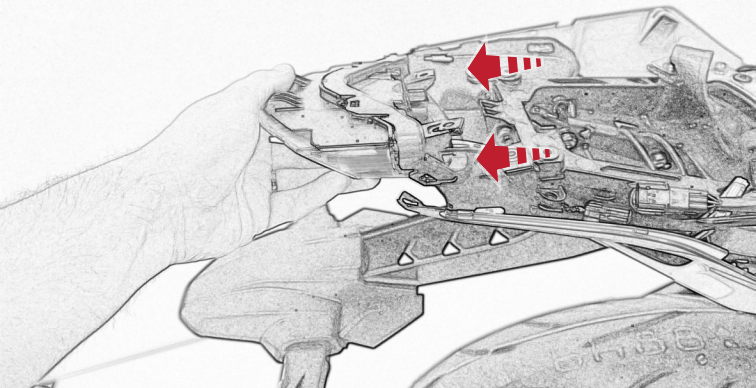

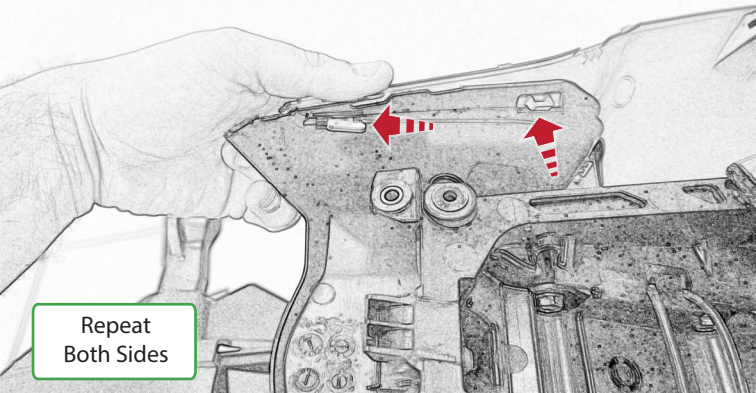

Repeat
Both Sides

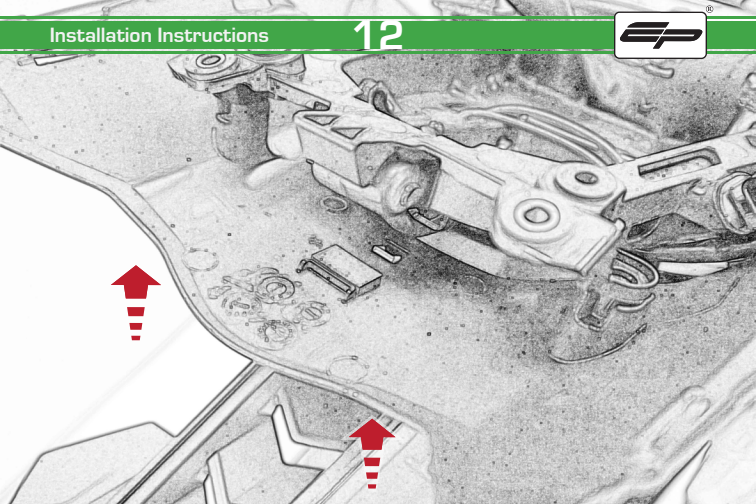

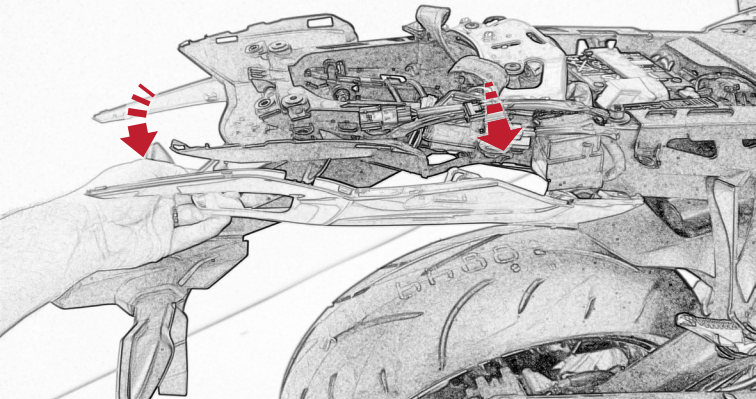

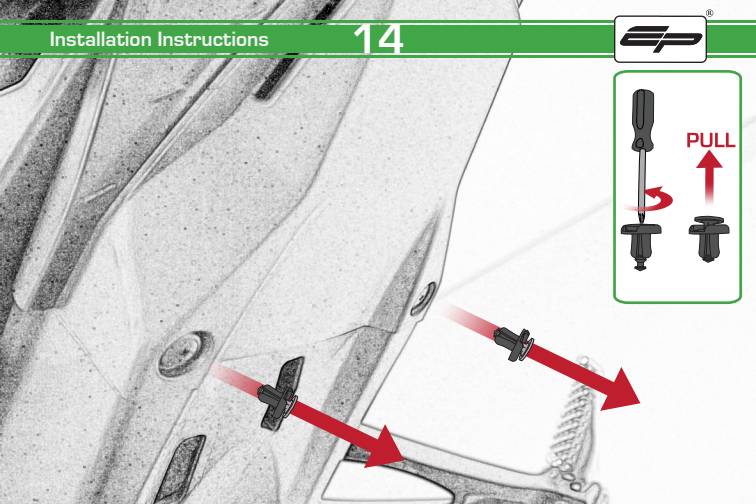
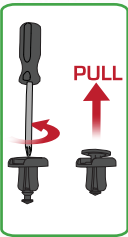



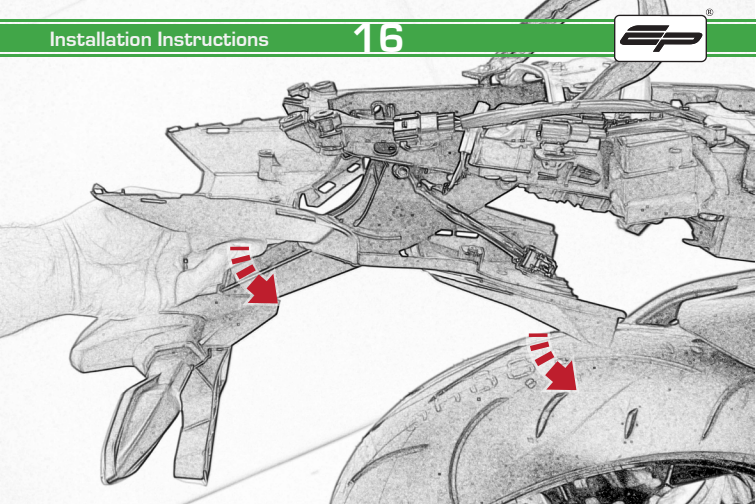

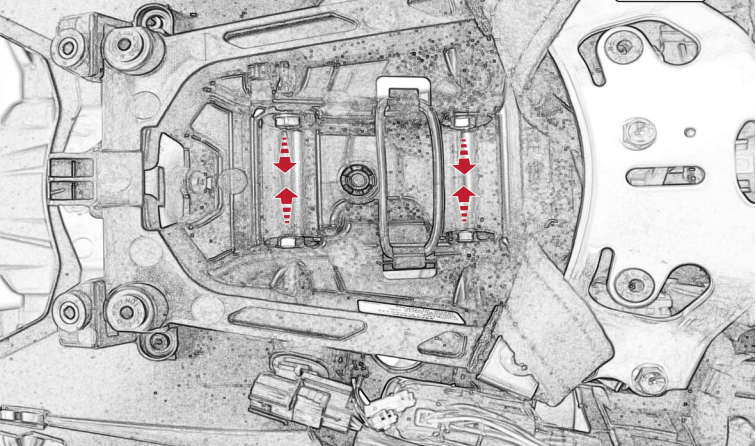

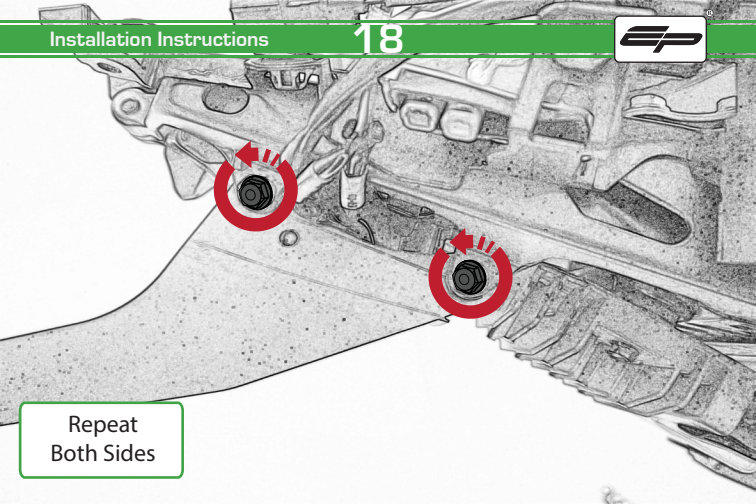

Repeat
Both Sides

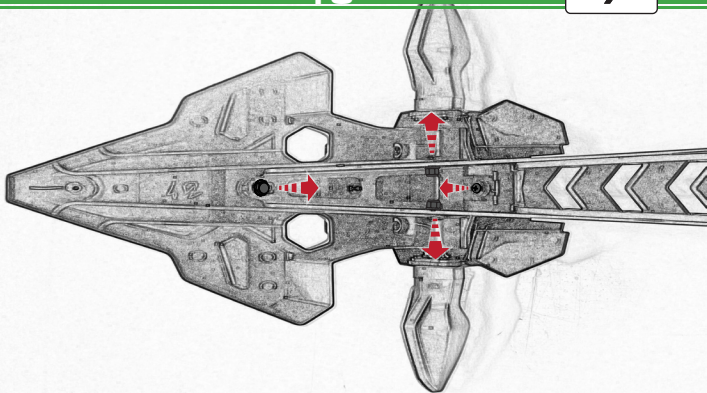

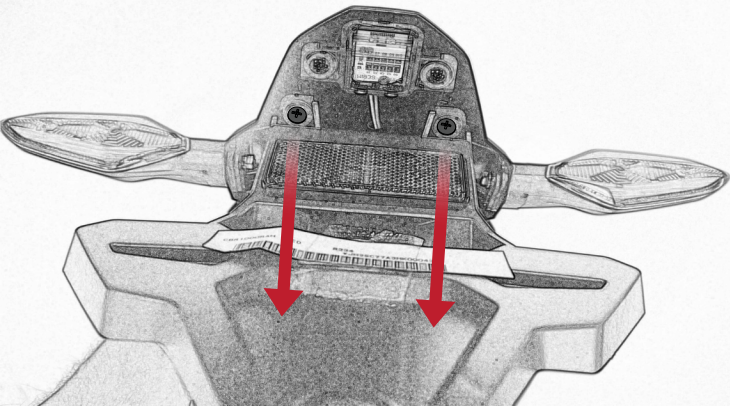

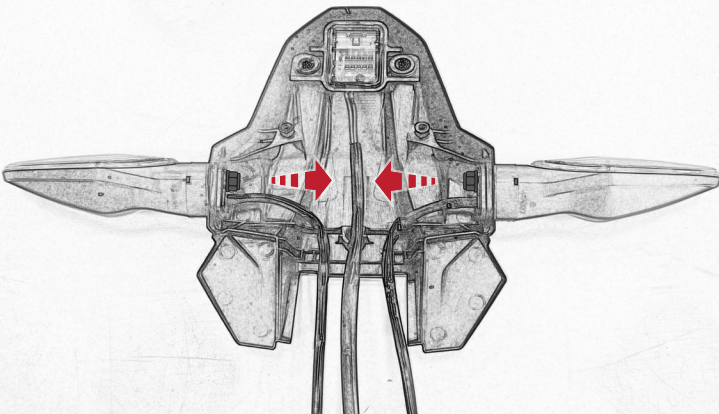

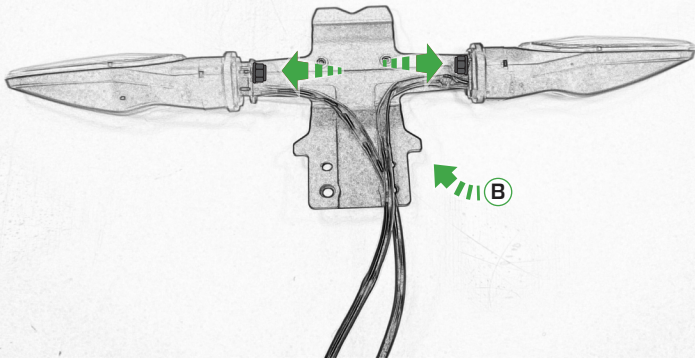

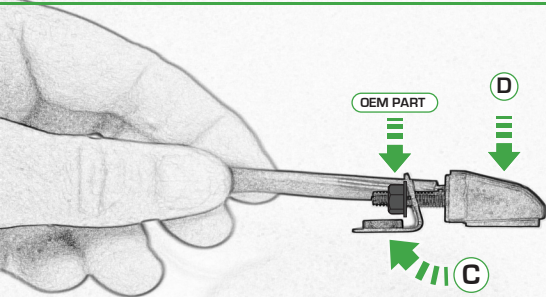

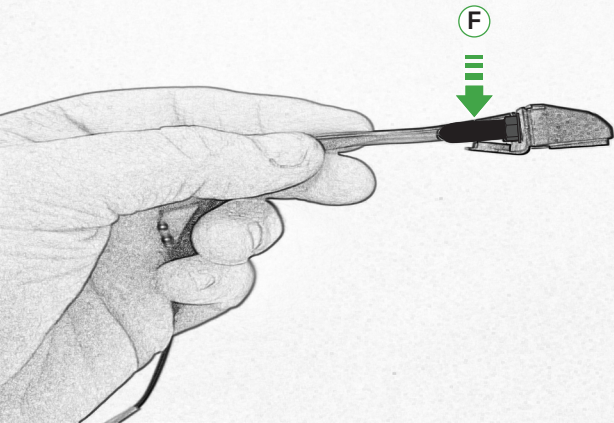



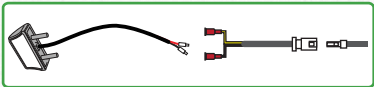
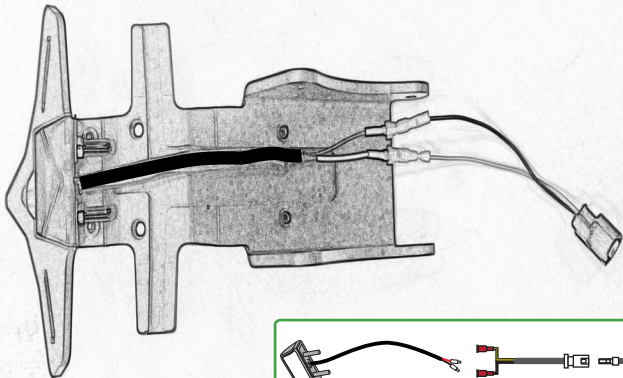

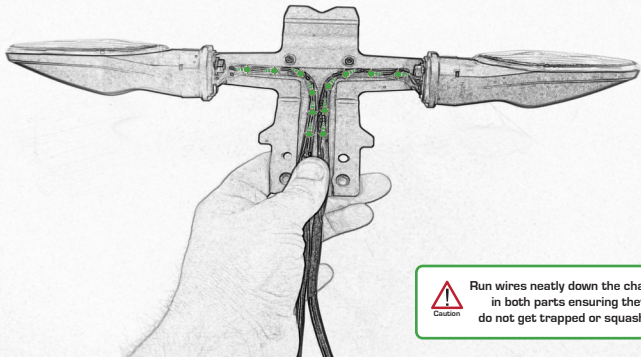

Caution

Run wires neatly down the channel
in both parts ensuring they
do not get trapped or squashed

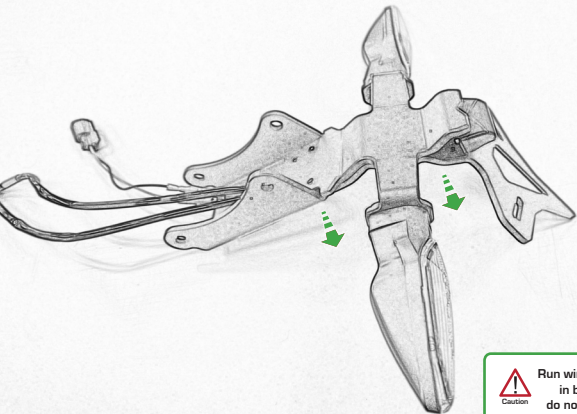

Run wires neatly down the channel in both parts ensuring they do not get trapped or squashed

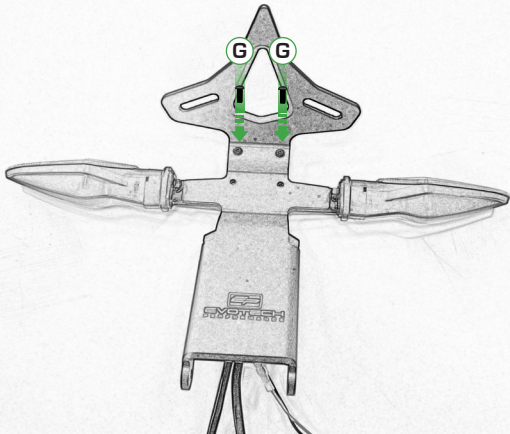

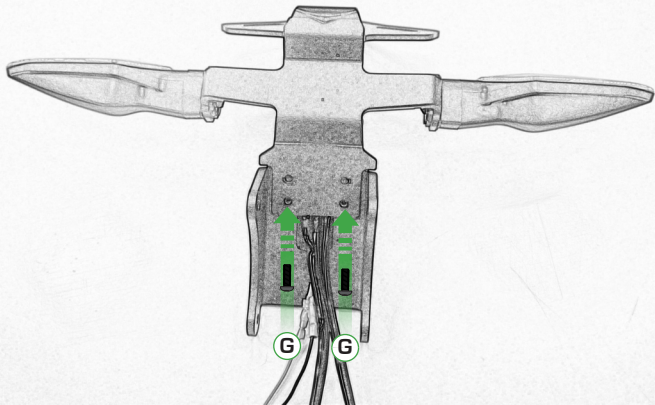

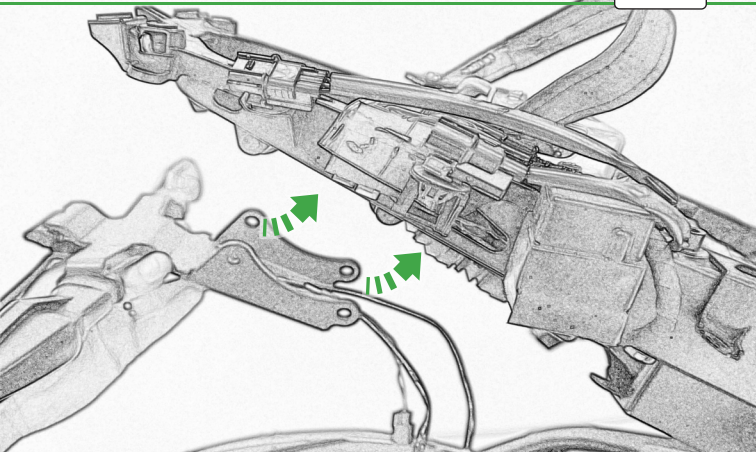

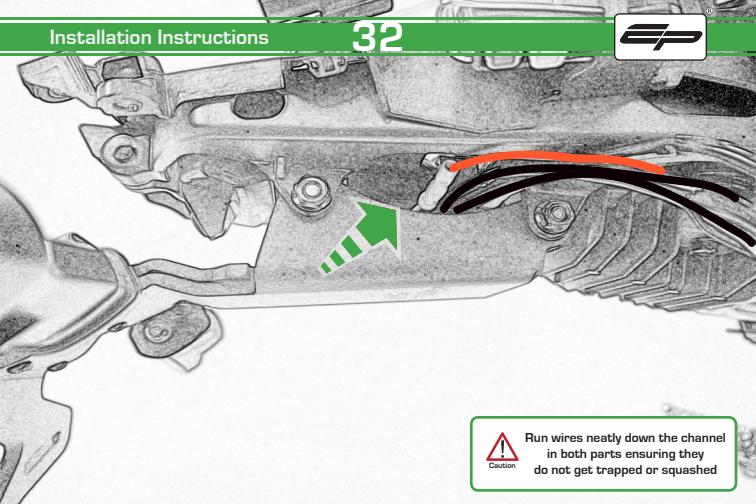

Caution

Run wires neatly down the channel
in both parts ensuring they
do not get trapped or squashed

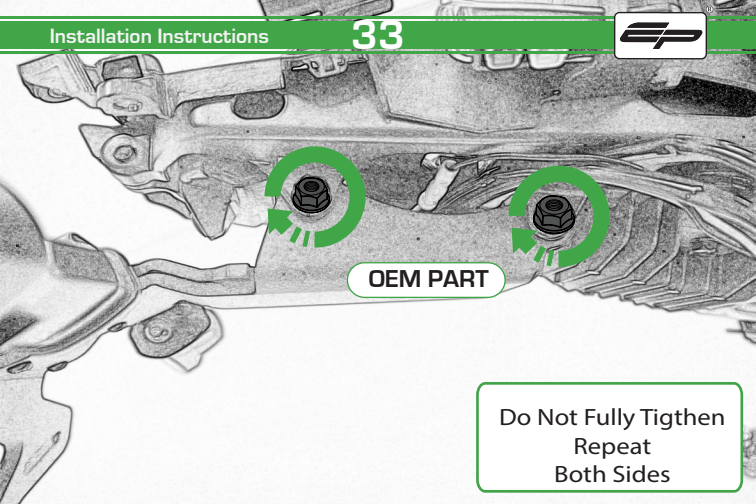

OEM PART

Do Not Fully Tighten
Repeat
Both Sides

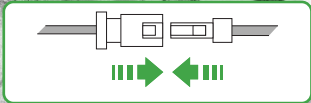
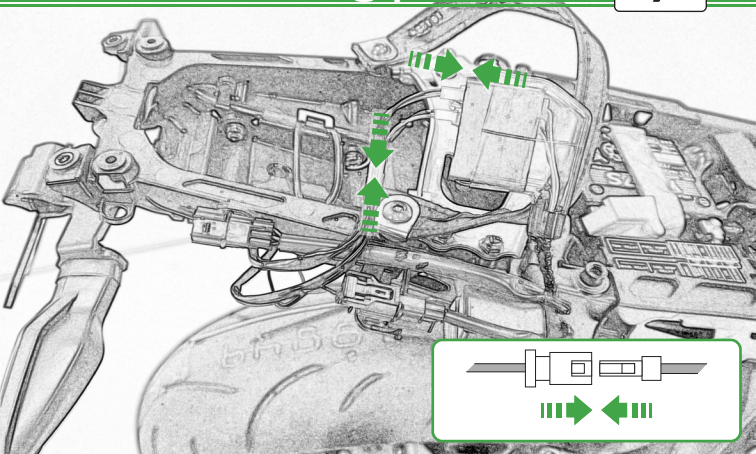

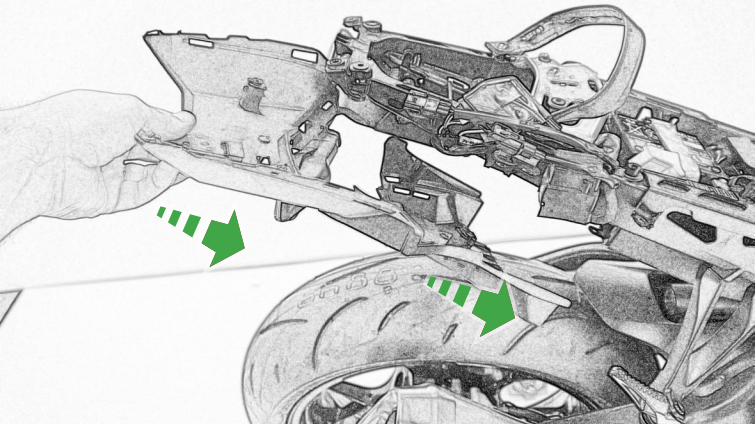



Caution

Please Ensure The Undertray
Is Located Behind The
Tail Tidy Main Bracket

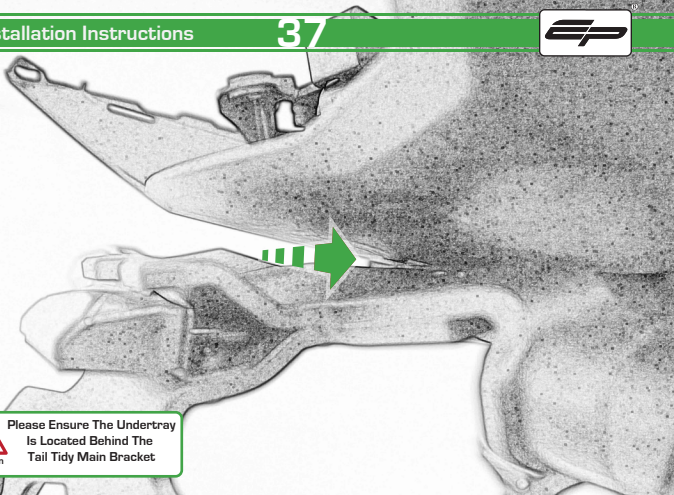

Caution

Please Ensure The Undertray
Is Located Behind The
Tail Tidy Main Bracket

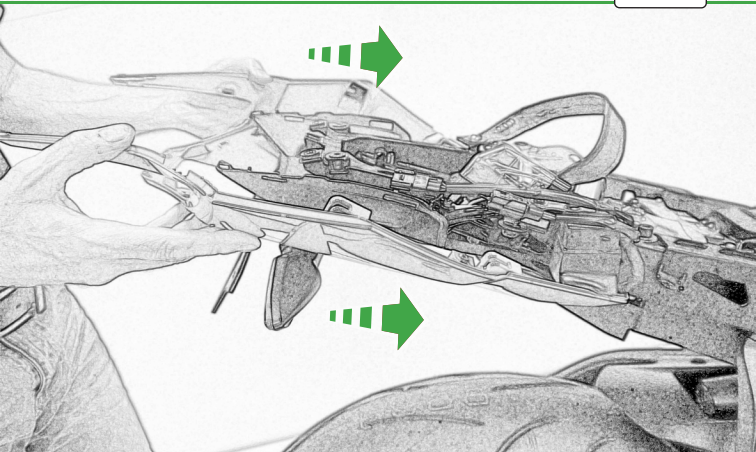

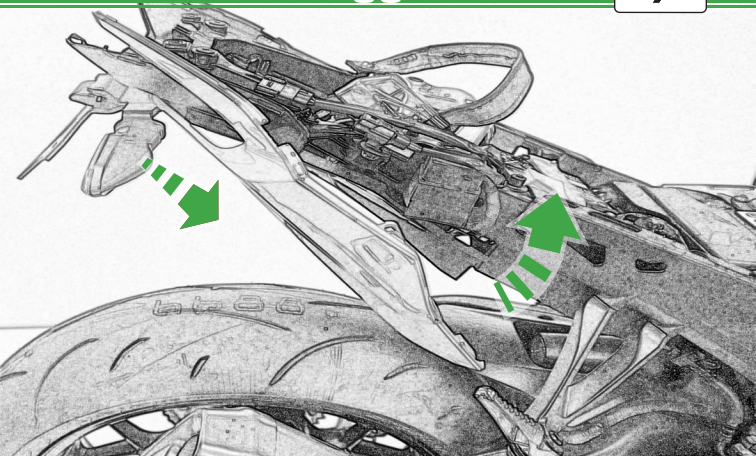

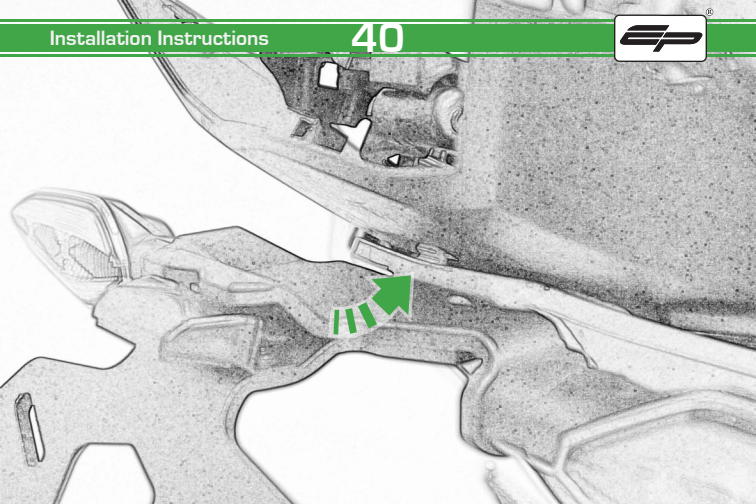

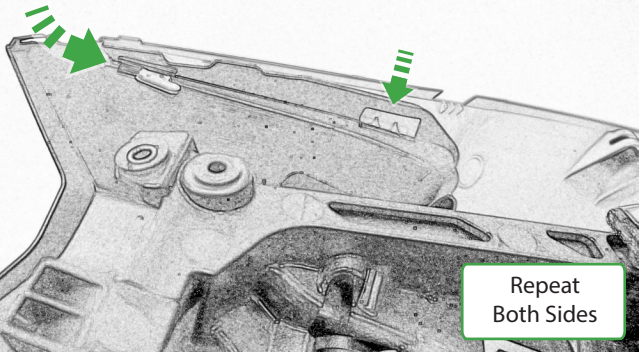

Repeat
Both Sides



Repeat
Both Sides

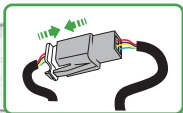
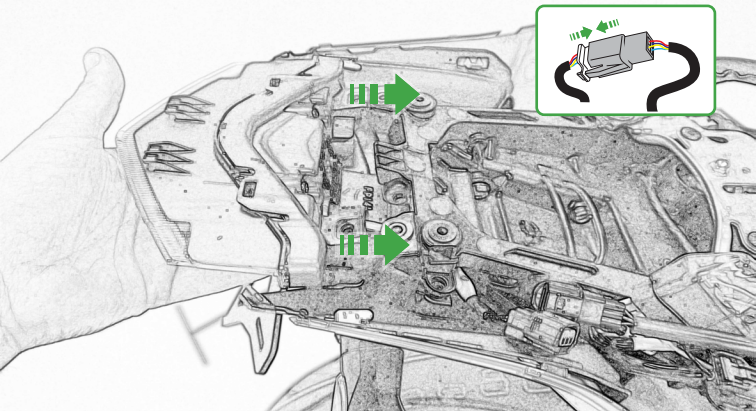

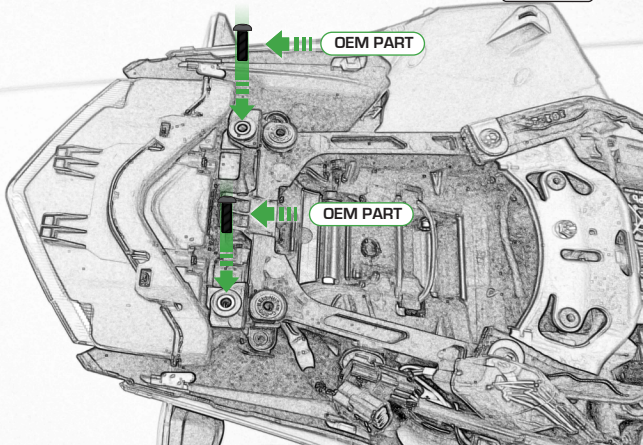

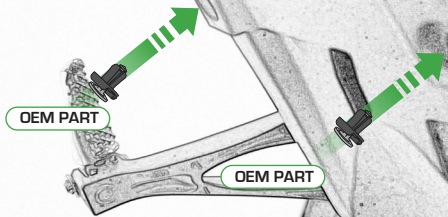

OEM PART

OEM PART

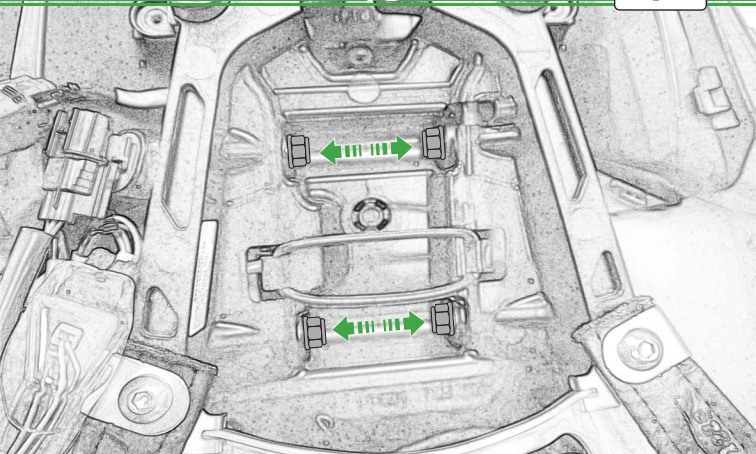



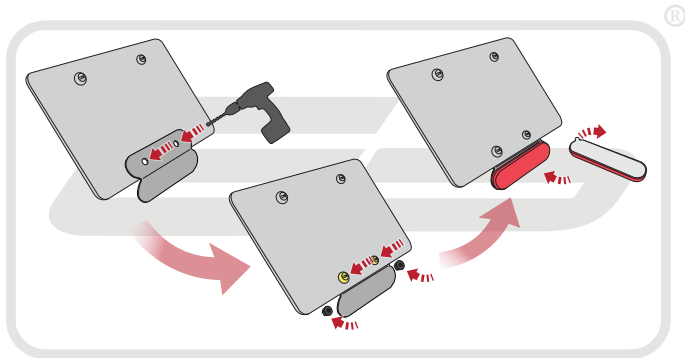

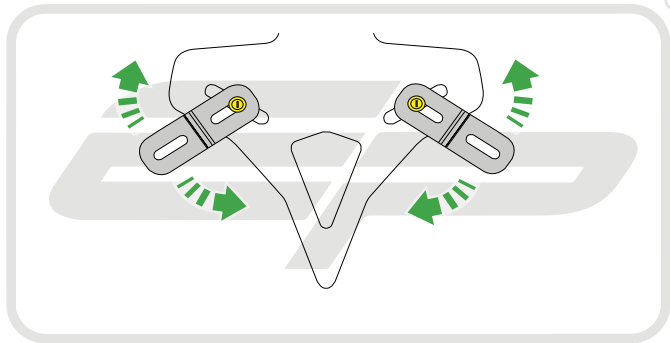



EVOTECH®
P E R F O R M A N C E

www.evotech-performance.com